

## Data Sheet

**Customer:**

**Product:** Carbon Film Leaded Resistor — CFR Series

**Sizes.:** 0318/0623/0932/1145/1550

**Issued Date:** 31-Oct-23

**Edition:** REV.B2



VIKING TECH CORPORATION  
光頡科技股份有限公司  
No.70, Guangfu N. Rd., Hukou  
Township, Hsinchu County  
303, Taiwan (R.O.C)

TEL:886-3-5972931  
FAX:886-3-5972935•886-3-5973494  
E-mail:sales@viking.com.tw

VIKING TECH CORPORATION KAOHSIUNG BRANCH  
光頡科技股份有限公司高雄分公司  
No.248-3, Sin-Sheng Rd., Cian-Jhen Dist., Kaohsiung,  
806, Taiwan

TEL:886-7-8217999  
FAX:886-7-8228229  
E-mail:sales@viking.com.tw

VIKING ELECTRONICS (WUXI) CO., LTD.  
光頡電子(無錫)有限公司  
No.22 Xixia Road, Machinery & Industry Park,  
National Hi-Tech Industrial Development Zone  
of Wuxi, Wuxi, Jiangsu Province, China  
Zip Code :214028  
TEL :86-510-85203339  
FAX :86-510-85203667•86-510-85203977  
E-mail :china@viking.com.tw

Produced by (QC)	Checked (QC)	Approved by (QC)	Prepared by (Sales)	Accepted by (Customer)
31-Oct-23	31-Oct-23	31-Oct-23	31-Oct-23	
<i>Kris Chen</i>	<i>Ben Chang</i>	<i>Ben Chang</i>		

## Carbon Film Leaded Resistor



### ■ Features

- The characteristics correspond to the IEC 60115-1 standard specification
- General-purpose lead-type resistors
- Automatic insertion is applicable
- Availability of various types and excellent long time stability
- Wide resistance range from 0.1 Ω to 10 MΩ

### ■ Applications

- Telecommunication
- Medical Equipment

### ■ Construction

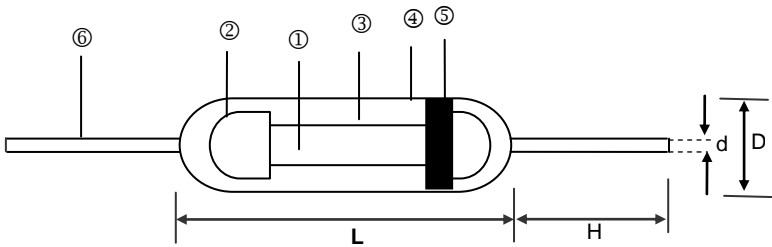

① Ceramic Rod	④ Non-flame Paint With Sol Vent-proof
② Tinned Iron Caps	⑤ Color Code
③ Carbon Film	⑥ Lead Wire

### ■ Dimensions

Unit: mm

Type	L	D	H	d	Weight (g) (1000pcs)
CFR0318	3.4±0.5	1.8±0.3	29±3.0	0.41~0.48	92
CFR0623	6.3±0.5	2.3±0.3	28±3.0	0.43~0.58	155
CFR0932	9.0±0.5	3.2±0.5	26±3.0	0.58~0.68	352
CFR1145	11.5±1.0	4.5±0.5	35±3.0	0.68~0.81	775
CFR1550	15.5±1.0	5.0±0.5	32±3.0	0.75~0.81	1042

### ■ Derating Curve

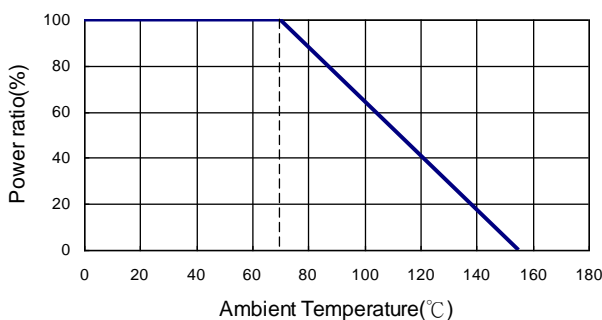

### ■ Hot-Spot Temperature

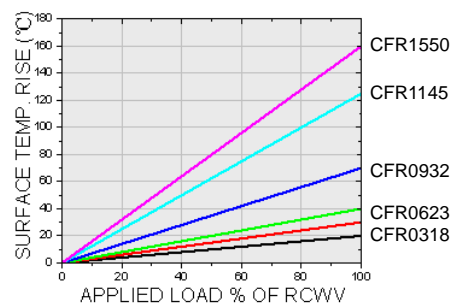

**Carbon Film Leaded Resistor**

**Part Numbering**

CFR	0318	J	T	-	W	1001	
Product Type	Dimensions (LxD)	Resistance Tolerance	Packaging Code	TCR (PPM/°C)	Power Rating	Resistance	Special
	0318: 3.4x1.8 0623: 6.3x2.3 0932: 9.0x3.2 1145: 11.5x4.5 1550: 15.5x5.0	J: ±5%	A: Ammo B: Bulk T: Taping Reel	-: No specified	R: 3W S: 2W T: 1W U: 1/2W V: 1/4W W: 1/8W	R500: 0.5Ω 0010: 1Ω 1000: 100Ω 2201: 2200Ω 1001: 1KΩ 1004: 1MΩ	: Standard MA: MA-type MC: MC-type FA: FA-type FB: FB-type FC: FC-type FD: FD-type

**Standard Electrical Specifications**

Item Type	Power Rating at 70°C	Operating Temp. Range	Max. Working Voltage	Max. Overload Voltage	Dielectric Withstanding Voltage	Resistance Range	
						±5%	
						E6	E24
0318	1/8W	-55 ~ +155°C	150V	300V	300V	0.1Ω – 0.68Ω	1Ω - 10MΩ
0623	1/4W		250V	500V	500V	0.1Ω – 0.68Ω	1Ω - 10MΩ
0932	1/2W		350V	700V	700V	0.1Ω – 0.68Ω	1Ω - 10MΩ
1145	1W		450V	1000V	1000V	0.1Ω – 0.68Ω	1Ω - 10MΩ
1550	2W		500V	1000V	1000V	0.1Ω – 0.68Ω	1Ω - 10MΩ

**High Power Rating Electrical Specifications**

Item Type	Power Rating at 70°C	Operating Temp. Range	Max. Working Voltage	Max. Overload Voltage	Dielectric Withstanding Voltage	Resistance Range	
						±5%	
						E6	E24
0318	1/4W	-55 ~ +155°C	200V	400V	400V	0.1Ω – 0.68Ω	1Ω - 10MΩ
0623	1/2W		300V	500V	500V	0.1Ω – 0.68Ω	1Ω - 10MΩ
0932	1W		400V	800V	800V	0.1Ω – 0.68Ω	1Ω - 10MΩ
1145	2W		500V	1000V	1000V	0.1Ω – 0.68Ω	1Ω - 10MΩ
1550	3W		500V	1000V	1000V	0.1Ω – 0.68Ω	1Ω - 10MΩ

Operating Voltage= $\sqrt{P \cdot R}$  or Max. operating voltage listed above, whichever is lower.

Overload Voltage= $2.5 \cdot \sqrt{P \cdot R}$  or Max. overload voltage listed above, whichever is lower

**Resistor body color:**

Standard power rating: Light Brown

High power rating 0318 size: Light Brown is available only other sizes: Light Brown or Pink are available.

Please specify which color is acceptable else the light brown is a top priority.

**For resistance value out of above range is by request. Below 10Ω are using alloy film.**

**■ Environmental Characteristics**

Item	Requirement	Test Method
Resistance Value	1Ω ~ 10MΩ	<b>IEC-60115-1 4.5</b> Measure at a distance of 10mm from the cap end
Short Time Overload	±(0.75%+0.05Ω)	<b>IEC-60115-1 4.13</b> 2.5 times RCWV for 5 seconds
Insulation Resistance	> 1000MΩ	<b>IEC-60115-1 4.6</b> The measure was executed by V-Block methods
Endurance	±(3%+0.05Ω)	<b>IEC-60115-1 4.25</b> 70±2°C, RCWV (or Umax., whichever less) for 1000 hrs with 1.5 hrs "ON" and 0.5 hrs "OFF"
Damp Heat, Steady State	<100KΩ±3% >101KΩ±5%	<b>IEC-60115-1 4.24</b> 40±2°C, 90~95% R.H. for 56 days, loaded with 0.1 times RCWV (or Umax., whichever less)
Solderability	95% min. Coverage	<b>IEC-60115-1 4.17</b> 245±5°C for 3±0.5 seconds
Voltage Proof	By Type	<b>IEC-60115-1 4.7</b> In V-Block for 60 seconds
Temperature Coefficient	1145/1550: < 1Ω ±1500ppmm 1Ω~100KΩ ±350ppm 100KΩ~1MΩ -0ppm-500ppm 1MΩ~ 10MΩ -0ppm-1000ppm  Other sizes: < 1Ω ±1500ppmm 1Ω~100KΩ +350ppm-500 ppm 100KΩ~1MΩ -0ppm-700ppm 1MΩ~ 10MΩ -0ppm-1500ppm	<b>IEC-60115-1 4.8</b> Resistance value at room temperature and room Temperature+100°C
Periodic-Pulse Overload Test	±(1%+0.05Ω)	<b>IEC-60115-1 4.39</b> 4 times RCWV (or Umax., whichever less) for 10000 cycles with 1 second "ON" and 25 seconds "OFF"
Solvent Resistance of Marking	No obvious deterioration of coatings and markings	<b>IEC-60115-1 4.30</b> IPA for 5±0.5 min. with ultrasonic
Robustness of Terminations	Tensile: ≥2.5 kg(24.5N)	<b>IEC-60115-1 4.16</b> Direct Load for 10 seconds In the direction off the terminal leads
Temperature Cycling	±(1%+0.05Ω)	<b>IEC-60115-1 4.19</b> -55°C/155°C with 5 cycles the duration at each temperature 30 min
Resistance to Soldering Heat	±(1%+0.05Ω)	<b>IEC-60115-1 4.18</b> The solder iron heated to 260°C ±5°C and applied to the termination for duration of 10±1 seconds.

RCWV(Rated continuous working voltage)=  $\sqrt{P \cdot R}$  or Max. Operating voltage whichever is lower

**■ Storage Temperature:25±10°C; Humidity < 80%RH**

**Taping/Packing Specifications**

**1. Standard Type (Reel & Ammo)**

Packing Methods

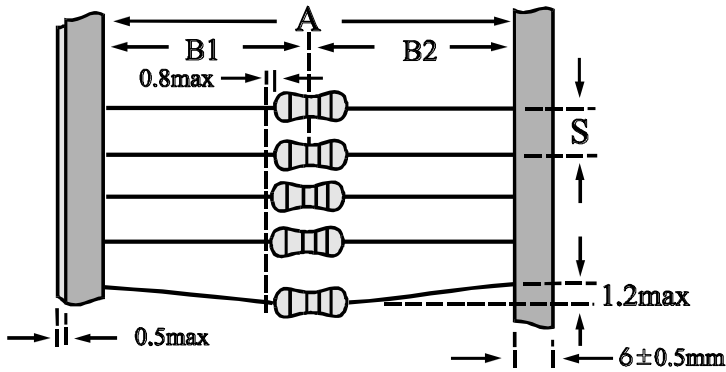

Reel Packing

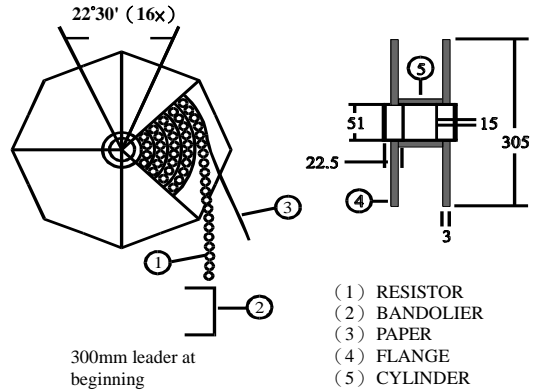

- (1) RESISTOR
- (2) BANDOLIER
- (3) PAPER
- (4) FLANGE
- (5) CYLINDER

Unit: mm

Packaging Type	Packing Methods			Reel Packing	
	A	B1-B2 Max	S	Across Flange (A)	Qty
0318	52+1/-0	1.2	5±0.3	72	5,000
	26+0.5/-0	1.0			
0623	52+1/-0	1.2	5±0.3	72	5,000
	26+0.5/-0	1.0			
0932	52+1/-0	1.2	5±0.3	72	2,500
1145	73+1/-0	1.5	5±0.3	95	2,000
	52+1/-0				
1550	73+1/-0	1.5	10±0.8	95	1,000
	52+1/-0				

Ammo Packing

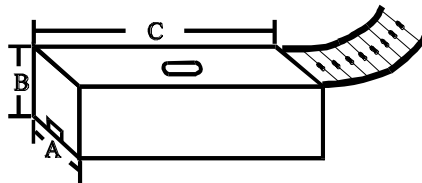

Unit: mm

Packaging Type	Packing Methods			Ammo Packing			
	A	B1-B2 Max	S	A	B	C	Qty
0318	52+1/-0	1.2	5±0.3	79±2	73±3	257±5	5,000
	26+0.5/-0	1.0		52±2	74±3	252±5	
0623	52+1/-0	1.2	5±0.3	79±2	100±3	257±5	5,000
	26+0.5/-0	1.0		52±2	109±3	252±5	
0932	52+1/-0	1.2	5±0.3	79±2	58±3	257±5	1,000
1145	73+1/-0	1.5	5±0.3	103±2	82±3	262±5	1,000
	52+1/-0			81±2	85±3	256±5	
1550	73+1/-0	1.5	10±0.8	103±2	96±3	265±5	1,000
	52+1/-0			82±2	108±3	258±5	

**2. Special Type (Bulk)**

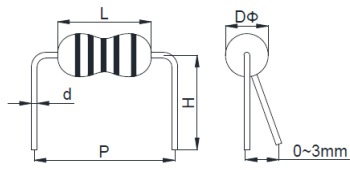

**MA Type**

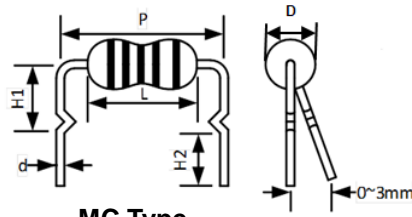

**MC Type**

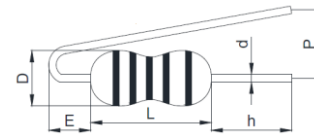

**FA Type**

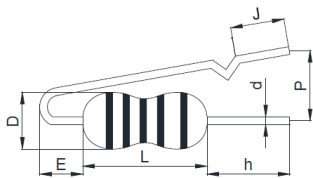

**FB Type**

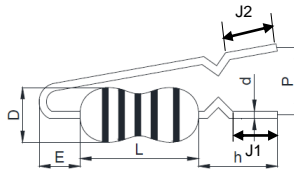

**FC Type**

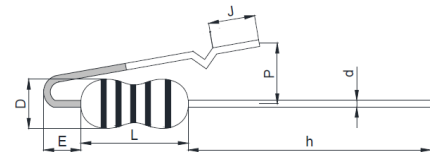

**FD Type**

Unit: mm

Codes	Type	P	H /H1/h	H2/G	J/J1/J2	D	L	d	E
0318	MA	5±1	8.0±1	-	-	1.8±0.3	3.4±0.5	0.45±0.03	-
0623	MA	10±1	10.0±1	-	-	2.3±0.3	6.3±0.5	0.55±0.03	-
	FD	5~15	27.0±2	-	12±2	2.3±0.3	6.3±0.5	0.55±0.03	3±1
0932	MA	12.5±1	10.0±1	-	-	3.2±0.5	9.0±0.5	0.65±0.03	-
	MC	12.5±1	6.5±2	3.5±2	-	3.2±0.5	9.0±0.5	0.65±0.03	-
	FA	5~15	5.0±2	-	-	3.2±0.5	9.0±0.5	0.65±0.03	3±1
	FB	5~15	4.0±2	-	3±2	3.2±0.5	9.0±0.5	0.65±0.03	3±1
	FC	5~15	10.0±3	-	4±2	3.2±0.5	9.0±0.5	0.65±0.03	3±1
1145	MA	15±1	12.5±1	-	-	4.5±0.5	11.5±1.0	0.78±0.03	-
	MC	15±1	9.5±2	4.5±2	-	4.5±0.5	11.5±1.0	0.78±0.03	-
	FA	5~15	5.0±2	-	-	4.5±0.5	11.5±1.0	0.78±0.03	3±1
	FB	5~15	4.0±2	-	3±2	4.5±0.5	11.5±1.0	0.78±0.03	3±1
	FC	5~15	10.0±3	-	4±2	4.5±0.5	11.5±1.0	0.78±0.03	3±1
1550	MA	20±1	15.0±1	-	-	5.0±0.5	15.5±1.0	0.78±0.03	-
	MC	20±1	13.5±2	3.5±2	-	5.0±0.5	15.5±1.0	0.78±0.03	-
	FA	5~15	5.0±2	-	-	5.0±0.5	15.5±1.0	0.78±0.03	3±1
	FB	5~15	4.0±2	-	3±2	5.0±0.5	15.5±1.0	0.78±0.03	3±1
	FC	5~15	10.0±3	-	4±2	5.0±0.5	15.5±1.0	0.78±0.03	3±1

**■ Marking & Resistance Tolerance**

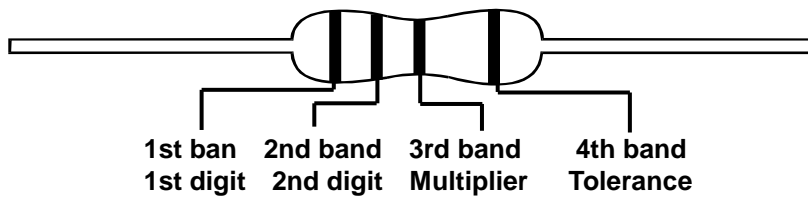

±5%	E-24	1.0	1.1	1.2	1.3	1.5	1.6	1.8	2.0	2.2	2.4	2.7	3.0	3.3	3.6	3.9	4.3	4.7	5.1	5.6	6.2	6.8	7.5	8.2	9.1
	E6	1.0			1.5			2.2			3.3			4.7			6.8								

Color	Digit	Multiplier	Tolerance	
Without	-	-	-	-
Silver	-	10 <sup>-2</sup>	-	-
Gold	-	10 <sup>-1</sup>	±5.0%	J
Black	0	10 <sup>0</sup>	-	-
Brown	1	10 <sup>1</sup>	-	-
Red	2	10 <sup>2</sup>	-	-
Orange	3	10 <sup>3</sup>	-	-
Yellow	4	10 <sup>4</sup>	-	-
Green	5	10 <sup>5</sup>	-	-
Blue	6	10 <sup>6</sup>	-	-
Violet	7	10 <sup>7</sup>	-	-
Grey	8	10 <sup>8</sup>	-	-
White	9	10 <sup>9</sup>	-	-