

Data Sheet

Customer:

Product: Metal Film Leaded Precision Resistor—MFR Series

Sizes.: 0318/0623/0932/1145/1550

Issued Date: 31-Oct-23

Edition: REV.B8



VIKING TECH CORPORATION
光頡科技股份有限公司
No.70, Guangfu N. Rd., Hukou
Township, Hsinchu County
303, Taiwan (R.O.C)

TEL:886-3-5972931
FAX:886-3-5972935•886-3-5973494
E-mail:sales@viking.com.tw

VIKING TECH CORPORATION KAOHSIUNG BRANCH
光頡科技股份有限公司高雄分公司
No.248-3, Sin-Sheng Rd., Cian-Jhen Dist., Kaohsiung,
806, Taiwan

TEL:886-7-8217999
FAX:886-7-8228229
E-mail:sales@viking.com.tw

VIKING ELECTRONICS (WUXI) CO., LTD.
光頡電子(無錫)有限公司
No.22 Xixia Road, Machinery & Industry Park,
National Hi-Tech Industrial Development Zone
of Wuxi, Wuxi, Jiangsu Province, China
Zip Code:214028
TEL:86-510-85203339
FAX:86-510-85203667•86-510-85203977
E-mail:china@viking.com.tw

Produced by (QC)	Checked (QC)	Approved by (QC)	Prepared by (Sales)	Accepted by (Customer)
31-Oct-23	31-Oct-23	31-Oct-23	31-Oct-23	
<i>Kris Chen</i>	<i>Ben Chang</i>	<i>Ben Chang</i>		

Metal Film Leaded Precision Resistor

■ Features

- Excellent overall stability
- Very tight tolerance down to $\pm 0.1\%$
- Extremely low TCR down to ± 10 PPM/°C
- High power rating up to 3 Watts
- Excellent ohmic contact

■ Applications

- Telecommunication
- Medical Equipment

■ Construction

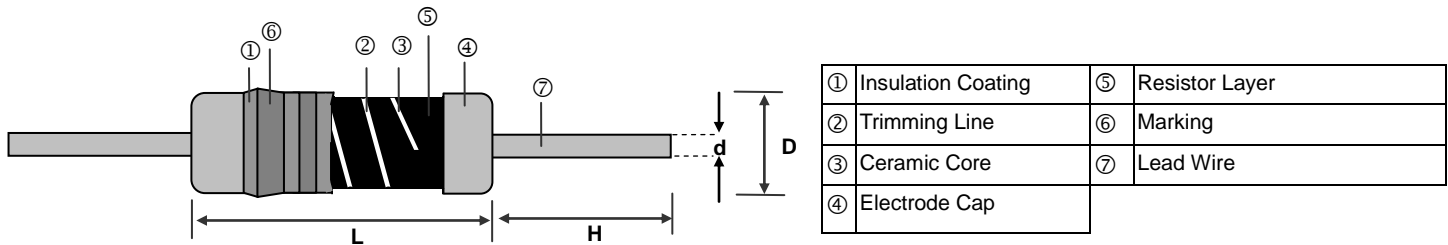

■ Dimensions

Unit: mm

Type	L	D	H	d	Weight (g) (1000pcs)
MFR0318	3.4±0.3	1.8±0.3	29±3.0	0.45±0.03	90
MFR0623	6.3±0.5	2.3±0.3	28±3.0	0.55±0.03	150
MFR0932	9.0±0.5	3.2±0.5	26±3.0	0.65±0.03	350
MFR1145	11.5±1.0	4.5±0.5	35±3.0	0.78±0.03	770
MFR1550	15.5±1.0	5.0±0.5	32±3.0	0.78±0.03	1040

■ Derating Curve

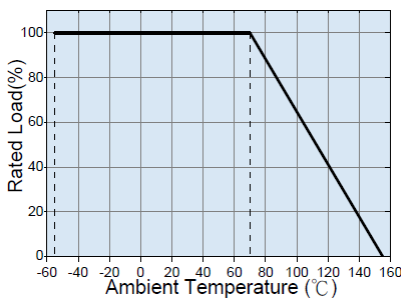

■ Hot-Spot Temperature

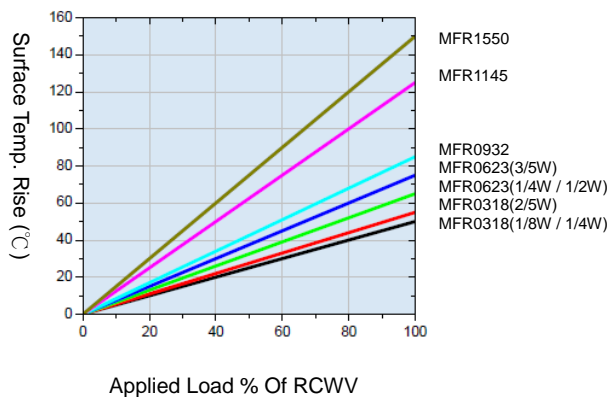

Part Numbering

MFR	0318	B	T	C	W	1001	
Product Type	Dimensions (LxD)	Resistance Tolerance	Packaging Code	TCR (PPM/°C)	Power Rating	Resistance	Special
	0318: 3.3x1.8 0623: 6.3x2.3 0932: 9.0x3.2 1145: 11.5x4.5 1550: 15.5x5.0	B: ±0.1% C: ±0.25% D: ±0.5% F: ±1%	A: Ammo B: Bulk T: Taping Reel	B: ±10 N: ±15 C: ±25 D: ±50 E: ±100	R: 3W S: 2W T: 1W F: 3/5W U: 1/2W G: 2/5W V: 1/4W W: 1/8W	R100: 0.1Ω 0010: 1Ω 1000: 100Ω 2201: 2200Ω 1001: 1KΩ 1004: 1MΩ	: Standard MA: MA-type MC: MC-type FA: FA-type FB: FB-type FC: FC-type FD: FD-type

Standard Electrical Specifications

Item Type	Power Rating at 70°C	Operating Temp. Range	Max. Operating Voltage	Max. Overload Voltage	Voltage Proof	Resistance Range				TCR (PPM/°C)
						±0.1%	±0.25%	±0.5%	±1%	
0318	1/8W	-55 ~ +155°C	150V	300V	300V	10Ω-1MΩ				±25
						10Ω-1MΩ		10Ω-4.99MΩ	10Ω-10MΩ	±50
						-	10Ω-1MΩ	10Ω-4.99MΩ	0.1Ω-10MΩ	±100
0623	1/4W	-55 ~ +155°C	250V	500V	500V	100Ω-22KΩ				±10
						10Ω-499KΩ				±15
						10Ω-1MΩ				±25
						10Ω-1MΩ		10Ω-4.99MΩ	10Ω-10MΩ	±50
						-	10Ω-1MΩ	10Ω-4.99MΩ	0.1Ω-10MΩ	±100
0932	1/2W	-55 ~ +155°C	350V	500V	500V	10Ω-1MΩ				±25
						10Ω-1MΩ		10Ω-4.99MΩ	10Ω-10MΩ	±50
						-	10Ω-1MΩ	10Ω-4.99MΩ	0.1Ω-10MΩ	±100
1145	1W	-55 ~ +155°C	500V	700V	700V	10Ω-1MΩ				±25
						10Ω-1MΩ		10Ω-4.99MΩ	10Ω-10MΩ	±50
						-	10Ω-1MΩ	10Ω-4.99MΩ	0.1Ω-10MΩ	±100
1550	2W	-55 ~ +155°C	500V	1000V	1000V	10Ω-1MΩ				±25
						10Ω-1MΩ		10Ω-4.99MΩ	10Ω-10MΩ	±50
						-	10Ω-1MΩ	10Ω-4.99MΩ	0.1Ω-10MΩ	±100

Operating Voltage= $\sqrt{P \cdot R}$ or Max. operating voltage listed above, whichever is lower.
 Overload Voltage= $2.5 \cdot \sqrt{P \cdot R}$ or Max. overload voltage listed above, whichever is lower.
 Value Range for standard resistance : below or over this resistance on request.

High Power & Ultra High Power Rating Electrical Specifications

Item Type	Power Rating at 70°C	Operating Temp. Range	Max. Operating Voltage	Max. Overload Voltage	Voltage Proof	Resistance Range				TCR (PPM/°C)						
						±0.1%	±0.25%	±0.5%	±1%							
0318	1/4W	-55 ~ +155°C	200V	400V	300V	10Ω-1MΩ				±25						
						10Ω-1MΩ		10Ω-4.99MΩ	10Ω-10MΩ	±50						
						-	10Ω-1MΩ	10Ω-4.99MΩ	0.1Ω-10MΩ	±100						
	2/5W		10Ω-1MΩ				±25									
			10Ω-1MΩ		10Ω-4.99MΩ	10Ω-10MΩ	±50									
			-	10Ω-1MΩ	10Ω-4.99MΩ	0.1Ω-10MΩ	±100									
0623	1/2W	-55 ~ +155°C	300V	500V	500V	100Ω-22KΩ				±10						
						10Ω-499KΩ				±15						
						10Ω-1MΩ				±25						
						10Ω-1MΩ		10Ω-4.99MΩ	10Ω-10MΩ	±50						
						-	10Ω-1MΩ	10Ω-4.99MΩ	0.1Ω-10MΩ	±100						
						3/5W	100Ω-22KΩ				±10					
	10Ω-499KΩ				±15											
	10Ω-1MΩ				±25											
	10Ω-1MΩ		10Ω-4.99MΩ	10Ω-10MΩ	±50											
	-		10Ω-1MΩ	10Ω-4.99MΩ	0.1Ω-10MΩ		±100									
	0932		1W	-55 ~ +155°C	400V		600V	500V	10Ω-1MΩ				±25			
						10Ω-1MΩ			10Ω-4.99MΩ	10Ω-10MΩ	±50					
-		10Ω-1MΩ				10Ω-4.99MΩ			0.1Ω-10MΩ	±100						
1145		2W				-55 ~ +155°C			500V	700V	700V	10Ω-1MΩ				±25
												10Ω-1MΩ		10Ω-4.99MΩ	10Ω-10MΩ	±50
												-	10Ω-1MΩ	10Ω-4.99MΩ	0.1Ω-10MΩ	±100
	1550		3W	-55 ~ +155°C	500V		1000V	1000V				10Ω-1MΩ				±25
												10Ω-1MΩ		10Ω-4.99MΩ	10Ω-10MΩ	±50
												-	10Ω-1MΩ	10Ω-4.99MΩ	0.1Ω-10MΩ	±100

Operating Voltage= $\sqrt{P \cdot R}$ or Max. operating voltage listed above, whichever is lower.
 Overload Voltage= $2.5 \cdot \sqrt{P \cdot R}$ or Max. overload voltage listed above, whichever is lower.
 Value Range for standard resistance · below or over this resistance on request.

Environmental Characteristics

Item	Requirement	Test Method
Resistance Value	1Ω-10MΩ	IEC-60115-1 4.5 Measure at a distance of 10mm from the cap end
Short Time Overload	±(0.25%+0.05Ω)	IEC-60115-1 4.13 2.5 times RCWV for 5 seconds
Insulation Resistance	> 1000MΩ	IEC-60115-1 4.6 The measure was executed by V-Block methods
Endurance	±(1.5%+0.05Ω)	IEC-60115-1 4.25 70±2°C, at RCWV (or Umax., whichever less) for 1000 hrs with 1.5 hrs "ON" and 0.5 hrs "OFF"
Damp Heat, Steady State	±(1.5%+0.05Ω)	IEC-60115-1 4.24 40±2°C, 90~95% R.H., for 56 days, loaded with 0.1 times RCWV (or Umax. whichever less)
Solderability	95% min. Coverage	IEC-60115-1 4.17 245±5°C for 3±0.5 seconds
Voltage Proof	By Type	IEC-60115-1 4.7 In V-Block for 60 seconds
Temperature Coefficient	By Type	IEC-60115-1 4.8 Resistance value at room temperature and room Temperature(+100°C)
Periodic-Pulse Overload Test	±(0.75%+0.05Ω)	IEC-60115-1 4.39 4 times RCWV(or Umax., whichever less) for 10000 cycles with 1sec "ON" and 25 sec "OFF"
Solvent Resistance of Marking	No obvious deterioration of coatings and markings	IEC-60115-1 4.30 IPA for 5±0.5 min. with ultrasonic
Robustness of Terminations	Tensile: ≥ 2.5kg(24.5N)	IEC-60115-1 4.16 Direct Load for 10 sec. In the direction off the terminal leads
Resistance to Soldering Heat	0318: ±(0.75%+0.05Ω) 0623&0932: ±(0.5%+0.05Ω) 1145&1550: ±(0.25%+0.05Ω)	IEC-60115-1 4.18 The solder iron heated to 260°C±5°C and applied to the termination for a duration of 10±1 seconds
Temperature Cycling	±(0.75%+0.05Ω)	IEC-60115-1 4.19 -55°C/125°C with 5 cycles. the duration at each temperature 30 min

RCWV(Rated continuous working voltage)= $\sqrt{P \cdot R}$ or Max. Operating voltage whichever is lower

Storage Temperature: 25±10°C; Humidity < 80%RH

Taping/Packing Specifications

1. Standard Type (Reel & Ammo)

Packing Methods

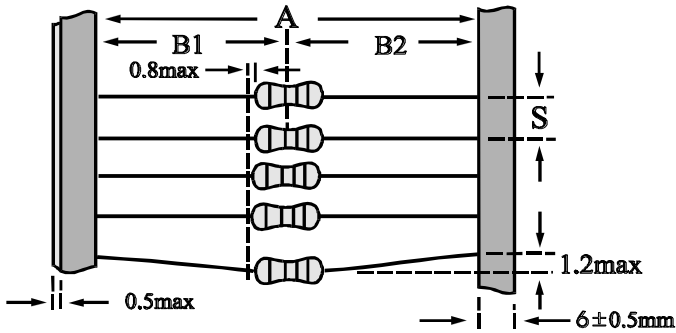

Reel Packing

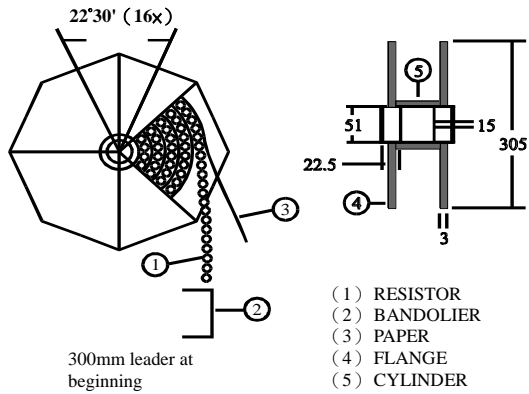

Unit: mm

Packaging Type	Packing Methods			Reel Packing	
	A	B1-B2 Max	S	Across Flange (A)	Qty
0318	52+1/-0	1.2	5±0.3	72	5,000
	26+0.5/-0	1.0			
0623	52+1/-0	1.2	5±0.3	72	5,000
	26+0.5/-0	1.0			
0932	52+1/-0	1.2	5±0.3	72	2,500
1145	73+1/-0	1.5	5±0.3	95	2,000
	52+1/-0				
1550	73+1/-0	1.5	10±0.8	95	1,000
	52+1/-0				

Ammo Packing

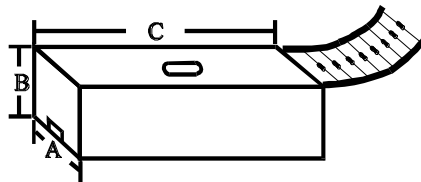

Unit: mm

Packaging Type	Packing Methods			Ammo Packing			
	A	B1-B2 Max	S	A	B	C	Qty
0318	52+1/-0	1.2	5±0.3	79±2	73±3	257±5	5,000
	26+0.5/-0	1.0		52±2	74±3	252±5	
0623	52+1/-0	1.2	5±0.3	79±2	100±3	257±5	5,000
	26+0.5/-0	1.0		52±2	109±3	252±5	
0932	52+1/-0	1.2	5±0.3	79±2	58±3	257±5	1,000
1145	73+1/-0	1.5	5±0.3	103±2	82±3	262±5	1,000
	52+1/-0			81±2	85±3	256±5	
1550	73+1/-0	1.5	10±0.8	103±2	96±3	265±5	1,000
	52+1/-0			82±2	108±3	258±5	

2. Special Type (Bulk)

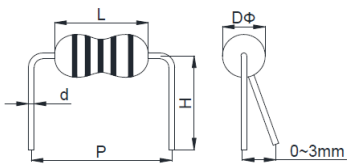

MA Type

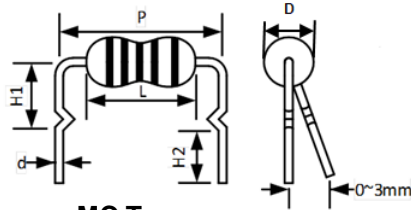

MC Type

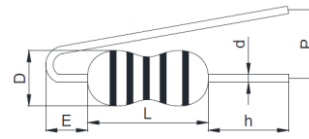

FA Type

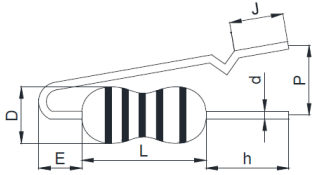

FB Type

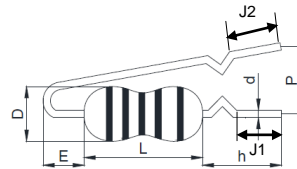

FC Type

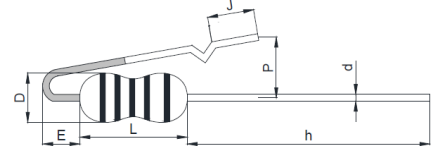

FD Type

Unit: mm

Codes	Type	P	H /H1/h	H2/G	J/ J1/J2	D	L	d	E
0318	MA	5±1	8.0±1	-	-	1.8±0.3	3.3±0.4	0.45±0.03	-
0623	MA	10±1	10.0±1	-	-	2.3±0.3	6.3±0.5	0.55±0.03	-
	FD	5~15	27.0±2	-	12±2	2.3±0.3	6.3±0.5	0.55±0.03	3±1
0932	MA	12.5±1	10.0±1	-	-	3.2±0.5	9.0±0.5	0.65±0.03	-
	MC	12.5±1	6.5±2	3.5±2	-	3.2±0.5	9.0±0.5	0.65±0.03	-
	FA	5~15	5.0±2	-	-	3.2±0.5	9.0±0.5	0.65±0.03	3±1
	FB	5~15	4.0±2	-	3±2	3.2±0.5	9.0±0.5	0.65±0.03	3±1
	FC	5~15	10.0±3	-	4±2	3.2±0.5	9.0±0.5	0.65±0.03	3±1
1145	MA	15±1	12.5±1	-	-	4.5±0.5	11.5±1.0	0.78±0.03	-
	MC	15±1	9.5±2	4.5±2	-	4.5±0.5	11.5±1.0	0.78±0.03	-
	FA	5~15	5.0±2	-	-	4.5±0.5	11.5±1.0	0.78±0.03	3±1
	FB	5~15	4.0±2	-	3±2	4.5±0.5	11.5±1.0	0.78±0.03	3±1
	FC	5~15	10.0±3	-	4±2	4.5±0.5	11.5±1.0	0.78±0.03	3±1
1550	MA	20±1	15.0±1	-	-	5.0±0.5	15.5±1.0	0.78±0.03	-
	MC	20±1	13.5±2	3.5±2	-	5.0±0.5	15.5±1.0	0.78±0.03	-
	FA	5~15	5.0±2	-	-	5.0±0.5	15.5±1.0	0.78±0.03	3±1
	FB	5~15	4.0±2	-	3±2	5.0±0.5	15.5±1.0	0.78±0.03	3±1
	FC	5~15	10.0±3	-	4±2	5.0±0.5	15.5±1.0	0.78±0.03	3±1

Metal Film Leaded Precision Resistor

■ Marking & Resistance Tolerance

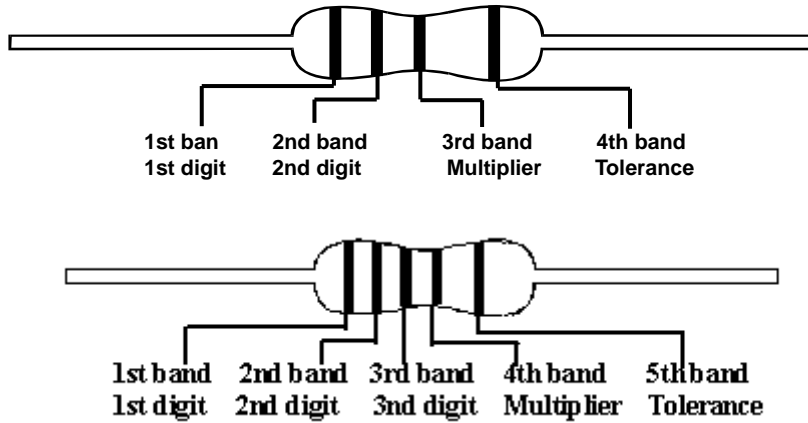

Color	Digit	Multiplier	Tolerance	
Without	-	-	±20%	M
Silver	-	10 ⁻²	±10%	K
Gold	-	10 ⁻¹	±5.0%	J
Black	0	10 ⁰	-	-
Brown	1	10 ¹	±1.0%	F
Red	2	10 ²	±2.0%	G
Orange	3	10 ³	-	-
Yellow	4	10 ⁴	-	-
Green	5	10 ⁵	±0.50%	D
Blue	6	10 ⁶	±0.25%	C
Violet	7	10 ⁷	±0.10%	B
Grey	8	10 ⁸	±0.05%	A
White	9	10 ⁹	-	-

±1.00%	E-24	1.0	1.1	1.2	1.3	1.5	1.6	1.8	2.0	2.2	2.4	2.7	3.0	3.3	3.6	3.9	4.3	4.7	5.1	5.6	6.2	6.8	7.5	8.2	9.1
±0.50%		1.00	1.02	1.05	1.07	1.10	1.13	1.15	1.18	1.21	1.24	1.27	1.30	1.33	1.37	1.40	1.43	1.47	1.50	1.54	1.58	1.62	1.65	1.69	1.74
±1.00%	E-96	1.78	1.82	1.87	1.91	1.96	2.00	2.05	2.10	2.15	2.21	2.26	2.32	2.37	2.43	2.49	2.55	2.61	2.67	2.74	2.80	2.87	2.94	3.01	3.09
		3.16	3.24	3.32	3.40	3.48	3.57	3.65	3.74	3.83	3.92	4.02	4.12	4.22	4.32	4.42	4.53	4.64	4.75	4.87	4.99	5.11	5.23	5.36	5.49
5.62		5.76	5.90	6.04	6.19	6.34	6.49	6.65	6.81	6.98	7.15	7.32	7.50	7.68	7.87	8.06	8.25	8.45	8.66	8.87	9.09	9.31	9.53	9.76	
±0.50%		10.0	10.1	10.2	10.4	10.5	10.6	10.7	10.9	11.0	11.1	11.3	11.4	11.5	11.7	11.8	12.0	12.1	12.3	12.4	12.6	12.7	12.9	13.0	13.2
±0.25%	E-192	13.3	13.5	13.7	13.8	14.0	14.2	14.3	14.5	14.7	14.9	15.0	15.2	15.4	15.6	15.8	16.0	16.2	16.4	16.5	16.7	16.9	17.2	17.4	17.6
		17.8	18.0	18.2	18.4	18.7	18.9	19.1	19.3	19.6	19.8	20.0	20.3	20.5	20.8	21.0	21.3	21.5	21.8	22.1	22.3	22.6	22.9	23.2	23.4
		23.7	24.0	24.3	24.6	24.9	25.2	25.5	25.8	26.1	26.4	26.7	27.1	27.4	27.7	28.0	28.4	28.7	29.1	29.4	29.8	30.1	30.5	30.9	31.2
		31.6	32.0	32.4	32.8	33.2	33.6	34.0	34.4	34.8	35.2	35.7	36.1	36.5	37.0	37.4	37.9	38.3	38.8	39.2	39.7	40.2	40.7	41.2	41.7
		42.2	42.7	43.2	43.7	44.2	44.8	45.3	45.9	46.4	47.0	47.5	48.1	48.7	49.3	49.9	50.5	51.1	51.7	52.3	53.0	53.6	54.2	54.9	55.6
		56.2	56.9	57.6	58.3	59.0	59.7	60.4	61.2	61.9	62.6	63.4	64.2	64.9	65.7	66.5	67.3	68.1	69.0	69.8	70.6	71.5	72.3	73.2	74.1
		75.0	75.9	76.8	77.7	78.7	79.6	80.6	81.6	82.5	83.5	84.5	85.6	86.6	87.6	88.7	89.8	90.9	92.0	93.1	94.2	95.3	96.5	97.6	98.8